



**AGA eR3
Model Nos
90, 90i**

**User Guide &
Installation Instructions**

CAUTION: THIS UNIT IS HEAVY, PROPER EQUIPMENT AND ADEQUATE MANPOWER MUST BE USED IN MOVING THE RANGE TO AVOID DAMAGE TO THE UNIT OR THE FLOOR.

REMEMBER, when replacing a part on this appliance, use only spare parts that you can be assured conform to the safety and performance specification that we require.

DO NOT use reconditioned or copy parts that have not been clearly authorised by AGA.

**PLEASE READ THESE INSTRUCTIONS BEFORE USING THIS APPLIANCE
AND KEEP IN A SAFE PLACE FOR FUTURE REFERENCE.**

Useful Information

It maybe useful to make a note of your AGA appliance Serial Number when it is being installed.

The serial number can be found on the rear of the appliance.

My AGA Details:

Serial No:

AGA Service No:

**AGA Dealer or store
contact No:**

Date of Installation:

Contents

1. Health and Safety	1	6. Warming oven shelf and plate rack	20
2. Introduction	3	7. AGA accessories	21
3. Overview	4	8. Cleaning & caring	23
The Controls	5	9. Maintenance	24
Cooker hoods and oven venting	5	10. Installation instructions	25
The Ovens	5	11. Installation introduction	26
General advice	6	12. Installation and Levelling	27
The hotplate	6	13. Product Dimensions	29
Hotplate control	7	14. Electrical connection	32
The resting plates	8	15. Control knob and handrail connection	33
The ovens	8	16. Circuit diagram	34
Roasting oven setting	9		
Baking oven setting	9		
Simmering oven	10		
Warming oven	10		
4. Cooking table	11		
5. 2 zone induction hotplate	12		
<i>(90i model only)</i>			
Pans	12		
Pan Detection	12		
Residual Heat Indicator	13		
Control Panel Fig. 5.1	13		
Overheat Protection	13		
Using the Induction Hob	13		
Pause	14		
Warming Function	14		
Auto Cook	15		
Timer Function	15		
1. Kitchen Timer	16		
Modify Kitchen Timer	16		
2. Minute Minder	17		
Modify Minute Minder	17		
3. Temporary Lock	18		
Bridge Function	19		

1. Health and Safety

NOTE : The installation manual and user guide for this appliance, are available online on www.agaliving.com.

- ⚠ Children less than 8 years of age shall be kept away unless continuously supervised. Cleaning and user maintenance MUST not be made by children without supervision.**
- ⚠ WARNING: ACCESSIBLE PARTS MAY BECOME HOT DURING USE. TO AVOID BURNS AND SCALDS CHILDREN SHOULD BE KEPT AWAY.**
- ⚠ WARNING: During use the appliance becomes hot. Care should be taken to avoid touching heating elements inside the ovens.**
- ⚠ WARNING : Any spillages should be removed from the hotplate lids before they are opened.**
- ⚠ WARNING : This appliance is not intended to be operated by means of an external timer not approved by AGA or a separate remote-control system.**
- ⚠ CAUTION: The cooking process has to be supervised. A short term cooking process has to be supervised continuously.**
- ⚠ WARNING: Danger of fire: Do not store items on the cooking surfaces.**
- ⚠ WARNING: Unattended cooking on a hob with fat or oil can be dangerous and may result in fire. NEVER try to extinguish a fire with water, but switch off the appliance and then cover flame e.g. with a lid or fire blanket.**
- ⚠ NEVER place anything aluminium between the saucepan base and the ceramic surface of the induction hob (i.e. cooking mats, aluminium foil, etc).**
- ⚠ IMPORTANT: Oil is a fire risk, NEVER leave pans containing oil or fat unattended during the heating or cooking period.**
- ⚠ NEVER fill the pan more than one-third fill of fat or oil.**
- ⚠ WARNING: If the induction hob surface is cracked, switch off the appliance to avoid the possibility of electric shock.**
- ⚠ Installation and maintenance must be performed by a qualified installer or service agency.**
- ⚠ WARNING! This appliance must be installed with an appropriate device that will allow permanent disconnection of the Live and Neutral conductors. During Installation or disconnection prior to any electrical work, the appliance must be permanently disconnected from the Supply (Live) and Neutral Conductors.**

- ⚠ If a supply cord is damaged it must be replaced by the manufacturer, its service agent or similarly qualified persons in order to avoid a hazard.**

This appliance operates on single phase. To adjust to 2 or 3 phase installation, an optional adapter kit must be obtained (Part No. AE4M280352).

- ⚠ DO NOT use a steam cleaner on your cooker.**
- ⚠ To avoid overheating, DO NOT install the cooker behind a decorative door.**
- ⚠ For correct installation of the oven shelves, refer to on page 11 "Oven shelves"**
- ⚠ DO NOT use abrasive pads, caustic cleaners, oven cleaners or metal scrapers to clean the surfaces of the enamel.**
- ⚠ IMPORTANT: AGA recommend Vitreous Enamel Association approved cleaners for cleaning the vitreous enamelled surfaces of this product.**
- ⚠ DO NOT put oven doors or resting plates in a dishwasher.**
- ⚠ Children should be supervised to ensure that they do not play with the appliance.**
- ⚠ Induction hobs; - Metallic objects such as knives , forks, spoons and lids should not be placed on the hob surface since they can get hot.**

The appliance can be used by children aged from 8 years and above and persons with reduced physical, sensory or mental capabilities or lack of experience and knowledge if they have been given supervision or instruction concerning use of the appliance in a safe way and understand the hazards involved.

The appliance may contain some of the materials that are indicated below. It is the Users/Installers responsibility to ensure that the necessary personal protective clothing is worn when handling where applicable, the pertinent parts that contain any of the listed materials that could be interpreted as being injurious to health and safety, see below for information.

Cooker Base or Hearth

It is essential that the base or hearth on which the cooker and should be level and capable of supporting the total weight of one or both units.

The front plinth cover is removable and must not be obstructed by flooring or tiles. If necessary the cooker must be raised by the thickness of the tiles to ensure the plinth can be removed.

Glues and Sealants

Exercise caution - if they are still in liquid form use face mask and disposable gloves.

Glass Yarn, Mineral Wool, Insulation Pads, Ceramic Fibre

May be harmful if inhaled. May be irritating to skin, eyes, nose and throat. When handling avoid contact with skin or eyes. Use disposable gloves, face-masks and eye protection. After handling wash hands and other exposed parts. When disposing of the product, reduce dust with water spray, ensure that parts are securely wrapped.

General

- In the event of a fire, cover the pan with a lid and switch OFF the electricity.
- Smother the flames on the hob rather than attempting to remove the pan to the outside.
- Burns and injuries are caused almost invariably by picking up the burning pan to carry outside.

Deep Fat Frying

- Use a deep pan, large enough to completely cover the appropriate heating area.

2. Introduction

As responsible manufacturers we take care to make sure that our products are designed and constructed to meet the required safety standards when properly installed and used.

Your AGA is a radiant heat stove cooker which combines the design values and cooking principles of the traditional AGA with the flexibility to turn each cooking area off and on as you require, thereby fitting into your lifestyle beautifully.

Refer to the diagram in the **Overview** chapter to familiarise yourself with the product and refer to the relevant sections for upper oven, lower oven, etc.

Any alteration that is not approved by AGA could invalidate the approval of the appliance, operation of the warranty and could affect your statutory rights.

In the interests of safety and effective use, please read the following before using your new AGA appliance.

Ensure that the kitchen is well ventilated: keep natural ventilation holes open or install a mechanical ventilation device (mechanical extractor hood).

Prolonged intensive use of the appliance may call for additional ventilation, for example, opening of a window, or more effective ventilation, for example increasing the level of mechanical ventilation where present.

Installation must be to local and national wiring regulations and carried out by a qualified engineer.

A little smoke and some odour may be emitted when first switched on. This is normal and harmless (from oven lagging and starch binder on the element insulation) and will cease after a short period of use.

3. Overview

Fig. 3.1



This model illustrate 90i

Fig. 3.2

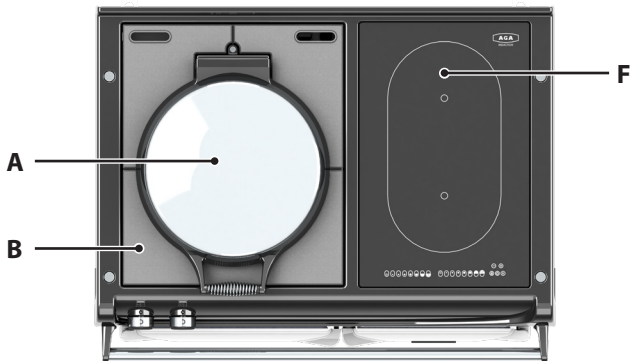

This model illustrate 90i

Cooker overview Fig. 3.1

- A. Simmering Plate and Boiling Plate
- B. Top Plate and Resting Area
- C. Top Oven (Roasting and Baking Oven)
- D. Simmering Oven
- E. Warming Oven
- F. Warming Plate (90 model only)
Induction Hotplate (90i model only).

Fig. 3.3

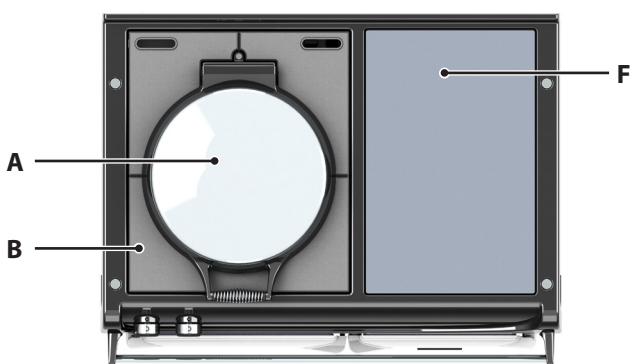

This model illustrate 90

The Controls

When switching on the AGA cooker for the first few times, there are two things you may notice, neither of which should cause concern.

The AGA cooker will emit an odour for a short while, this is simply due to the protective oil we put on the hotplate and ovens burning off. Due to the newness in the first couple of hours, it is advisable to open the kitchen window while this takes place.

Condensation may occur on the top and front plate whilst the AGA cooker is heating up, caused by the insulation lagging and starch binder on the element insulation drying out. The condensation should be wiped away as soon as possible to prevent staining the enamel.

Your AGA has the external appearance of a classic AGA heat storage enamelled cast iron cooker. However, it's flexibility is almost unbounded because in place of a single heat source each cooking zone has its own electrically heated cast iron element (s). The separation of cooking zones, allows a choice of control. You are able to select only the zones that you want, or need, to use.

Cooker hoods and oven venting

It is recommended that this AGA is fitted with a cooker hood above it. The AGA venting system is located on top of the AGA and is designed for venting the moisture from the ovens. The cooker hood should be positioned not less than the minimum height as recommended by the manufacturer, from the top of the AGA.

The Ovens











The AGA Roast/Bake and Simmer ovens are manufactured from cast iron, over a period of time they will become individually seasoned.

However, the ovens will rust if high moisture content foods are not covered (especially in the simmering oven) or spillages are not cleaned up.

It is also not advisable to leave a full or partially filled saucepan/utensils with high moisture content food in the ovens when they are not in use.

To season the ovens a light vegetable oil is ideal (corn oil is best), spray oil is recommended. Any stubborn stains can be removed with the wire brush supplied.

The warming oven and storage compartment are manufactured from coated steel and do not need to be seasoned.

Hobs	
OFF	
Simmering	
Boiling	
Oven	
OFF	
Roast oven ON Simmer OFF	
Roast oven ON Simmer ON	
Top oven - OFF Simmer ON	
Baking ON Simmer ON	
Baking ON Simmer OFF	
Warming Oven	
Bottom Right-hand Oven ON = Green Neon	

General advice

Food should not be placed into any oven until it is up to normal operating heat.

The oven doors should not be left open for long periods of time during cooking and heating up.

Store the cold plain shelf outside the cooker. Use it cold in the roasting oven to deflect heat from the top of the oven, creating a more moderate oven temperature underneath. It can also be used as a baking sheet.

Warm up times

As the AGA works on the principle of storing heat, time is required to gather that heat from the electric elements to saturate the castings. **We recommend to allow an hour heat up time.** The optional programmer is a great asset as it can be set to get the top oven to its working heat, ready for you to cook when you walk through the door.

The principle of heat storage means that the ovens and hotplate are at a pre-set heat, the cooking areas are named after their function rather than temperatures.

The hotplate

The cast iron hotplate is operated manually and is machined flat to give the best all-over contact with the AGA saucepans, grill pan, frying pan and kettle.

The boiling plate setting is the hottest with the simmering plate setting being cooler. It has electric elements embedded into the cast iron which heat up in approximately 12-15 minutes. The hotplate can be used completely independently from the ovens.

The whole hotplate area can be used for cooking and several pans can be accommodated on the plate at any one time. The hotplate is set very slightly above the top plate to minimise scratching as the pans are pulled to one side to simmer.

The chrome insulated cover is brought down over the hotplate when it is heating up or not in use. When the hotplate is 'ON' the insulated cover will be warm. We strongly advise not to put anything such as kettles, saucepans or baking tins directly onto the insulated cover because it will show any scratches - invest in a chef's pad to protect the surface if the cover is to be used as a resting place!

Keep the hotplate clear of any burnt on food or crumbs by brushing with the wire brush, supplied with your AGA. Cleaning details can be found **on page 23 "Cleaning & caring"**.

Hotplate control

The boiling plate setting (Fig. 3.4)

The hottest setting, the boiling plate setting is used for boiling, grilling, stir-frying, making toast - indeed anything that requires a high heat. Green vegetables keep their colour when boiled quickly here, or use a steamer over the saucepans to cook more than one vegetable at once.

When stir-frying or cooking anything that is inclined to splash we would recommend using an AGA Splash Shield which will protect the insulated cover from splatter, making cleaning a doddle! Just wash the Splash Shield in hot soapy water or place in a dishwasher between two dinner plates.

Please be advised the boiling plate setting is too hot to cook food directly on it.

The simmering plate setting (Fig. 3.5)

The simmering plate setting is the cooler of the two settings and so is used for recipes that require a lower heat such as, making sauces, scrambling eggs, heating milk, slow frying, simmering soups and root vegetables. In addition, it can be used to cook on directly as a form of griddle - invaluable for toasted sandwiches, quesadillas, drop scones, searing scallops and even a non-fat fried egg! Slow cooked toast can be made on the simmering plate setting, no need to use the AGA toaster here.

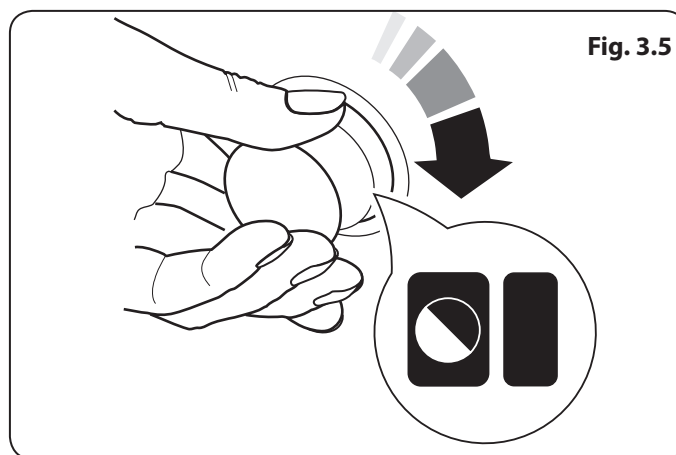
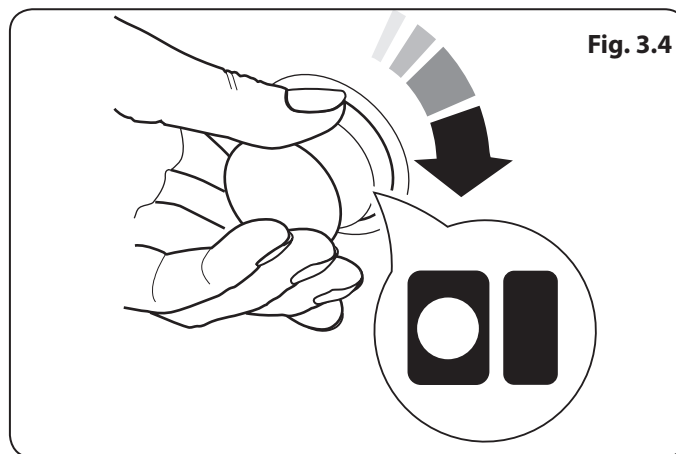
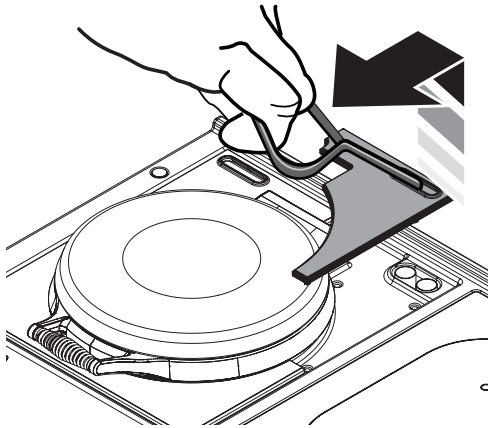

Fig. 3.6



The resting plates

The resting plates are useful when you wish to move a pan off boil or to a lower temperature.

Take care when removing and replacing the cast iron resting plates, as they are heavy. Ensure they are cold before removing.

Removing resting plates

Insert lifting tool **Fig. 3.6** in recess at rear of resting plate. Lift up at rear, the slide out carefully from the side, **Fig. 3.7**.

Replacement of resting plates

Replace resting plates carefully, as shown in **Fig. 3.8**.

Fig. 3.7

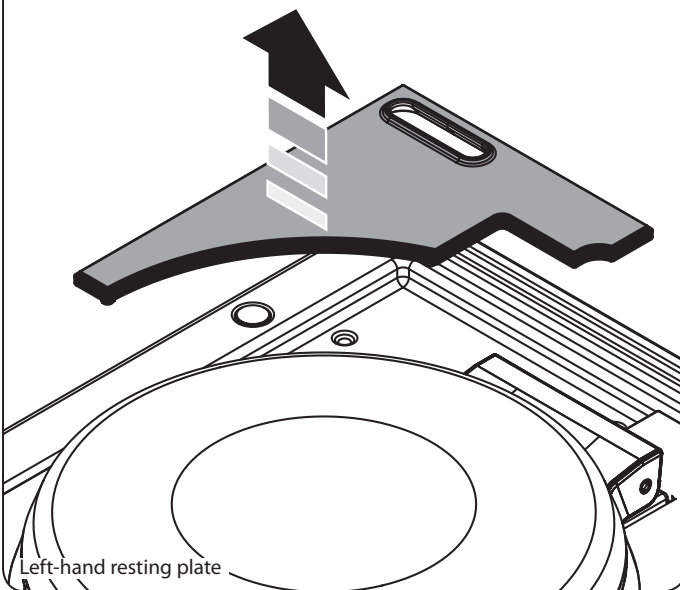

The ovens

Your AGA has two ovens which are pre-set at a different heat plus a warming oven, just like the traditional AGA heat storage cooker. The top oven has two temperature settings one for roasting and one for baking.

Each oven has the same capacity, (able to fit a 13kg (28lb) turkey) and the traditional AGA heat-storage cooker techniques can be used, such as stacking saucepans in the simmering oven. This enables the steaming of root vegetables, rice, steamed pudding, casserole, poaching fruit all in the same oven leaving the hotplate free.

The two main ovens are made from cast iron, which cooks by a radiant heat and this is the secret of the cooking excellence for which the AGA cooker is renowned. An indirect radiant heat does not dry food out, so it retains its natural moisture and flavour.

Top Left-Hand Oven

 The roasting oven setting for high temperature cooking

 The baking oven setting for moderate temperature cooking.

Bottom Left-Hand Oven

 The simmering oven for long, slow cooking.

Warming Oven

 The Warming oven

Fig. 3.8



⚠ DO NOT OPERATE THIS APPLIANCE WITH THE DOORS OPEN, SINCE THIS CAN CAUSE A LOCK-OUT.

Roasting oven setting

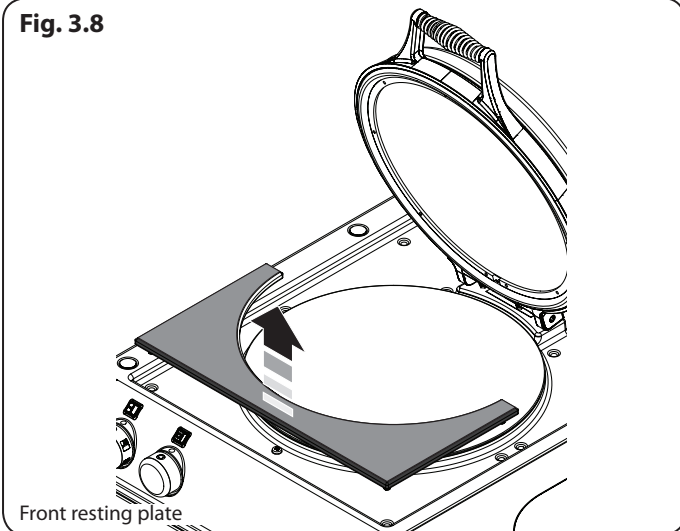

The roasting oven setting is indirectly heated by two elements, one in the base of the oven and the other in the roof. These elements heat the cast iron within to provide cooking results consistent with the traditional AGA heat-storage cooker, with the flexibility of being able to turn

the oven off when not in use.

The roasting oven setting can be used for 'grilling' at the top and 'shallow frying' on the oven floor.

When cooking on the base of the roasting oven, place the floor grid on the base before putting the food into the oven. This lifts the food away from the base element to ensure best cooking results are achieved.

The roasting oven setting is zoned in heat, meaning it is slightly hotter towards the top than the centre and the oven grid shelf set on the oven floor is slightly less hot than the centre.

The beauty of the roasting oven setting is that any fat is burnt off when the oven is at full heat, just brush out occasionally to remove the carbon deposits.

The roasting oven setting is excellent for bread and pastries. Quiches in ceramic or pies in Pyrex dishes need not be baked blind as when they are in placed on the floor grid on the base of the oven the pastry cooks from underneath and the filling will set and brown from the all-round heat. As you are aware metal flat tins conduct heat quicker than ceramic and may need less cooking time.

The specially designed AGA roasting tins and bakeware slide directly onto the runners, so almost every available square centimetre of space can be used. Food can be protected by the use of the cold plain shelf or shielded by means of the large roasting tin which means you can cook food that requires different temperatures at the same time. If food is browning too quickly and you do not want to move it to another oven just slide the cold plain shelf over the food to reduce the top heat.

Baking oven setting



The baking oven setting is indirectly heated by two elements, one in the base of the oven and the other in the roof. These elements heat the cast iron within to provide cooking results consistent with traditional AGA heat storage cookers, with the flexibility of being able to turn it off when not in use.

This setting is a moderate heat, so is ideal for cakes, biscuits, also anything that requires medium heat cooking such as fish pie, lasagne, soufflés, crumble and roulades. Meat and poultry can be cooked here indeed most things that can be cooked on the roasting oven setting can be cooked on the baking oven setting but for a longer time.

For the best results when cooking cakes do allow at least the one hour heat up time. Cook cakes together on one shelf. If two shelves are used interchange the food to achieve even colouration, as you would with any oven which is zoned heat.

As with the roasting oven setting, the specially designed AGA roasting tins and bakeware slide directly onto the runners, so almost every available square centimetre of space can be used. Food can be protected by the use of the cold plain shelf or shielded by means of the large roasting tin, which means that you can cook food that requires different temperatures at the same time. If food is browning too quickly and you do not want to move it to another oven just slide the cold plain shelf over the food to reduce the heat.

NOTE: When baking it is always best to start from cold, otherwise if baking after using the roasting setting the oven will take a considerable amount of time to cool.

NOTE: Always remove the cold plain shelf and roasting tins on completion of cooking, if left in the oven it will affect the oven temperature.

Simmering oven



The simmering oven is indirectly heated by one element in the base of the oven.

This element heats the air and the cast iron within it to provide cooking results consistent with the traditional simmering oven of the traditional AGA heat-storage cooker, with the flexibility of being able

to turn it off when not required.

The floor grid is used here to protect items placed on the base of the oven such as vegetables for steaming, keeping sauces warm or casseroles cooked for a long time. Always ensure this is in place, before putting food into the oven.

The simmering oven can be described as a continuation oven, it continues to cook food that has been brought up to heat elsewhere on the cooker with the exception of meringues which are dried out rather than 'cooked'.

Warming oven



The warming oven is indirectly heated by one element in the base of the oven.

The **OVEN IS NOT A HOLDING OVEN** and therefore is not designed to hold food at a given temperature for long periods.

The warming oven is designed to keep prepared food warm for a short period until it is convenient to serve.

The warming oven is supplied with a plate rack facility for warming before serving.

⚠ Plates should NOT be left in for long periods to avoid damage.

Operate the warming oven via the separate switch at the right-hand side of the hotplate. A green neon indicates that the warming oven is on.

User Guidance

- Allow the ovens to heat fully, the longer the oven is on the better, we recommend one hour.
- To get the very best performance, we recommend to use AGA cookware with thick bases and stacking lids.
- **DO NOT** place dishes directly on to the oven base. Always place onto either a shelf or the floor grid.
- Joints of meat and poultry should be brought up to heat ideally on the roasting oven setting for 30-45 minutes, then transferred to the simmering oven.
- This method is unsuitable for stuffed meat and stuffed poultry).
- Make sure that pork and poultry reach an internal temperature of at least 75°C.
- Always bring soups, casseroles and liquids to the boil before putting in the simmering oven.
- Always thaw frozen food completely before cooking.
- Root vegetables will cook better if cut into small pieces.
- Adjust seasoning and thickenings at the end of the cooking time.
- Many dried pulses and beans for example, dried red kidney beans must be boiled for a minimum of 10 minutes, after soaking, and before inclusion in any dish.

4. Cooking table

Roasting oven setting	Oven temperature = HIGH
Grilling	Top - grilling
Scones	2nd runner - scones, small pastries, grilling
Pastries	3rd runner - bread rolls , Yorkshire pudding
Bread	4th runner - roasts, poultry
Yorkshire puddings	Oven grid shelf on base of oven - bread loaves, pies, roast vegetables
Roasts	Floor grid on base of oven - quiches, pies
Shallow frying	
Baking oven setting	Oven temperature = MODERATE
Cakes	Towards top - whisked sponges, some biscuits, small cakes
Biscuits	Middle - fish, soufflés, shepherd and cottage pie, lasagne
Fish Shepherds pie, Cottage pie Lasagne Soufflés Shortbread	Oven grid shelf on base of oven - Victoria sandwiches, shortbread, traybakes and cheesecake
Simmering oven	Oven temperature = LOW
Casseroles Milk puddings Stock Meringues Rich fruit cake	For casseroles, stock, milk puddings and similar dishes bring to heat on the hotplate or induction hob, then transfer to the simmering oven (one exception is meringues). Rich fruit cakes can be cooked here for a, long time on the oven grid shelf placed on the base of the oven.

Residual Heat Indicator

The hob surface will get hot when in use, this is due to heat being conducted from the cooking pan. The hob surface will also remain hot for a while after use.

After the cooking period the hob hot indicator (**Fig. 5.4**) will be displayed and for a short period of time after power off.

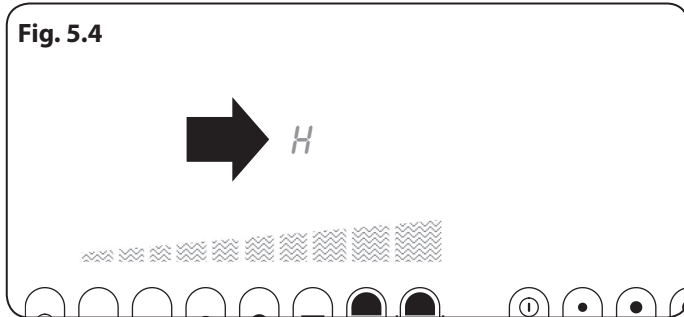

Control Panel Fig. 5.1

Always use positive finger contact on the touch pads to ensure a good control response.

Touch pads may not respond if the hob control area is wet. Touch pad area should be dried using paper towel.

Overheat Protection

Power levels will be automatically reduced if excessive high temperatures are monitored below the cooking zone. If high temperatures are detected it will not be possible to adjust the power level to a higher level than shown in the visual displays.

Should a pan be allowed to boil dry the overheat system will turn the hob off.

Using the Induction Hob

Step 1. To switch on touch the standby.

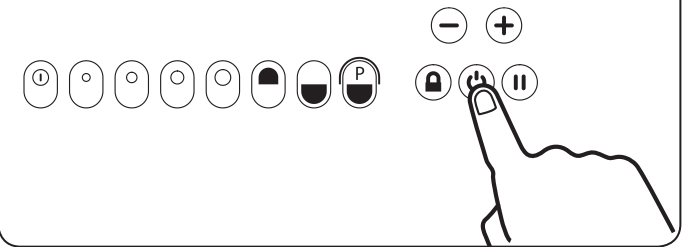

Step 2. Touch the induction on. If power level is not set within 20 seconds the unit will automatically switch off.

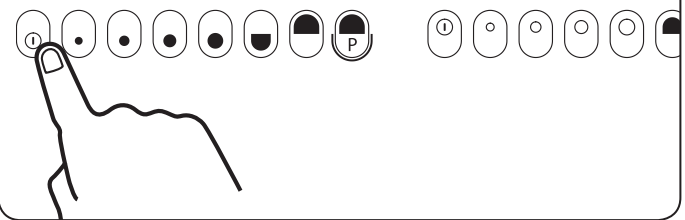

Step 3. Set the required power level.

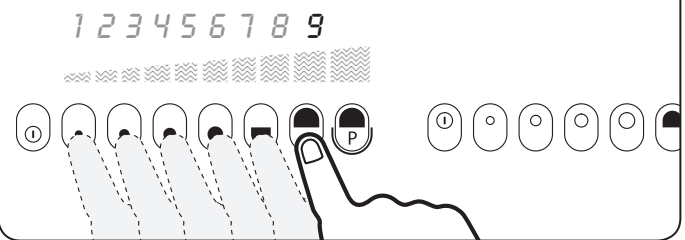

Step 4. Boost level. Power boost will last for 10 mins, before reverting back to setting.

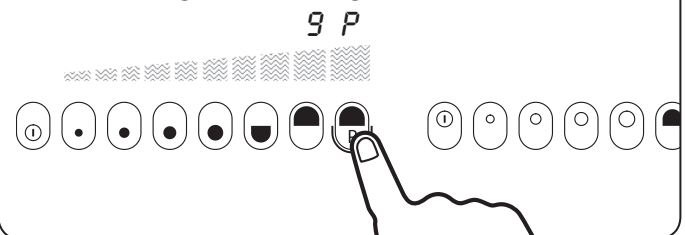

Step 5. To switch off touch the standby.

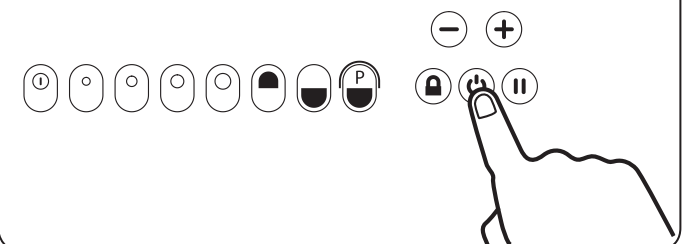

Pause

Step 1. To interrupt the cooking period, touch the pause.

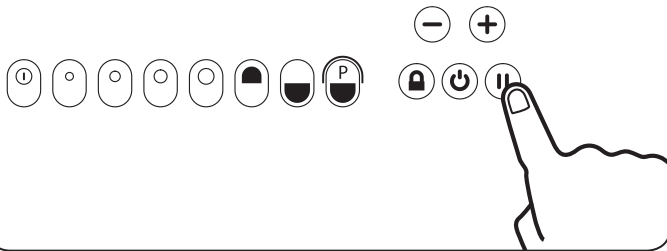

Step 2. To recommence cooking, touch the pause and slide your finger the full length of the power level pads.

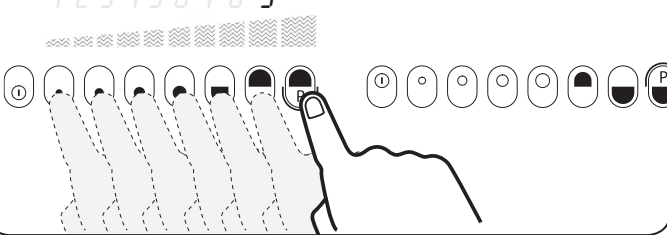

Step 3. The original power level will be automatically set.

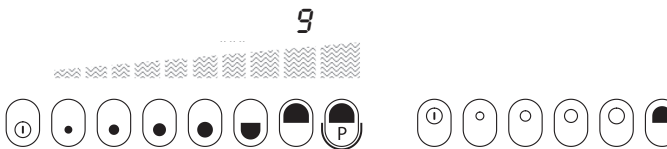

Pause remains active for 10 minutes only, after 10 minutes the hob will switch off.

Warming Function

The warming function will keep cooked food warm for a set period of time.

Level	Temperature	
1	40°C 104°F	Melting
2	70°C 158°F	Warming
3	94° C	Simmer

Step 1. To switch on touch the standby.

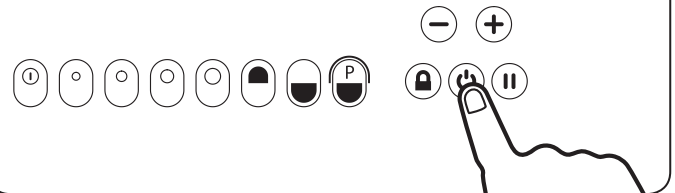

Step 2. Touch the induction on. If power level is not set within 20 seconds the unit will automatically switch off.

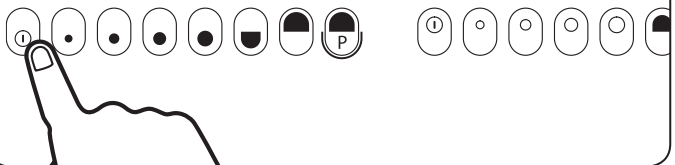

Step 3. Touch the first power level pad to select warming level one.



Step 4. To select the second warming level, touch and hold the first power level.

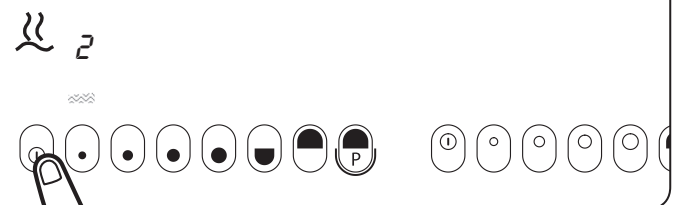

Step 5. To select the third warming level, touch and hold the first power level.

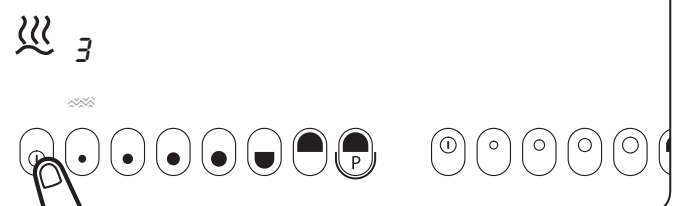

Auto Cook

The Auto Cook feature allows the pan contents to be brought up to a high temperature rapidly, before reverting back to the set power level.

Step 1. To switch on touch the standby.

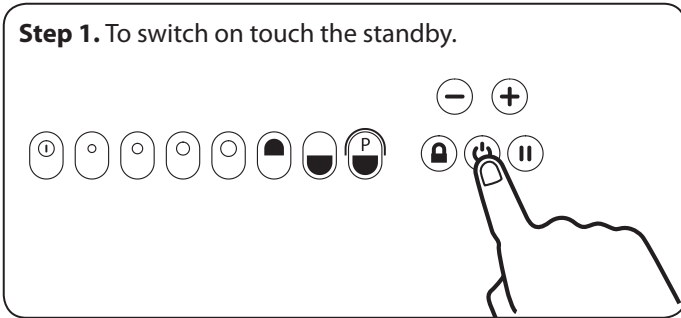

Step 2. Touch the induction on. If power level is not set within 20 seconds the unit will automatically switch off.

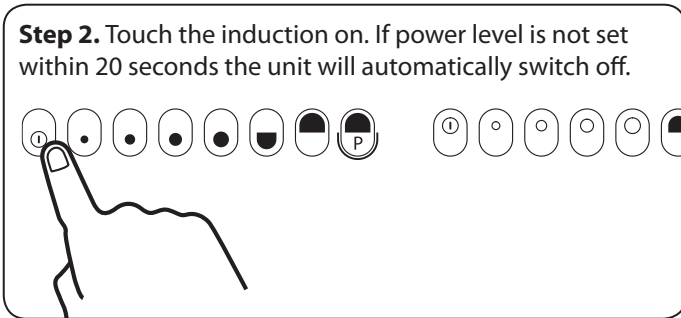

Step 3. Touch required power level pad for 5 seconds. The symbol *R* along with the power level, will flash in the display.

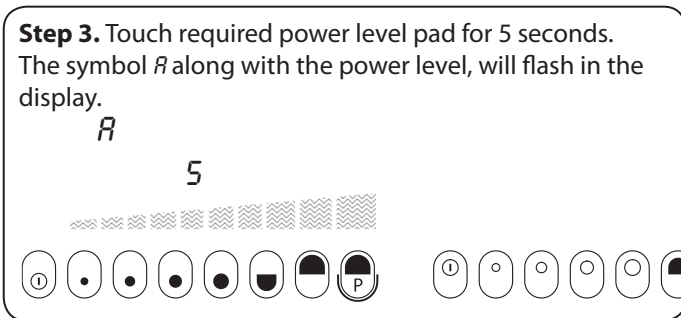

Step 4. To switch off touch the standby.

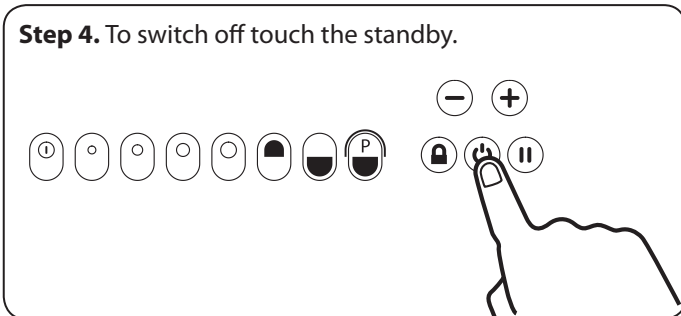

Timer Function

The timer functions do not start or stop a cooking process. The hob has two individual timers:

1. **Kitchen Timer**, for general kitchen timing requirements, for example, timing food cooked in an oven.
2. **Minute Minder**, for timing the duration of the induction cooking process.

1. Kitchen Timer

Step 1. To switch on touch the standby.

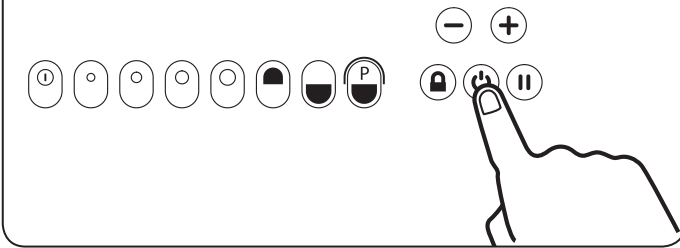

Step 2. Press the "-" and "+" button together.

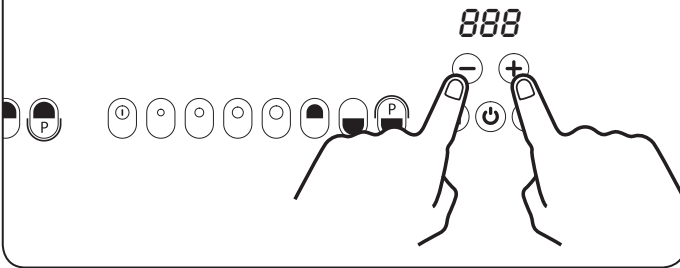

Step 3. A time can now be set using - or +. The count down will commence after a few seconds.

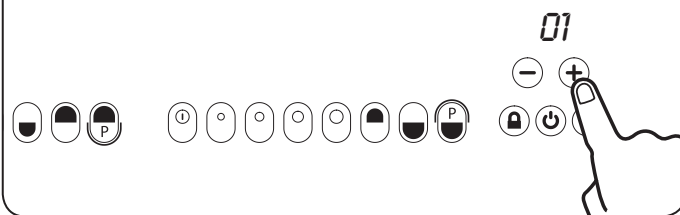

Step 4. If an instant countdown is required touch the power pad.

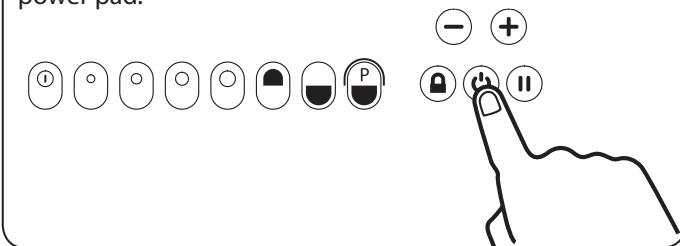

Step 5. If an instant countdown is required touch the power pad.

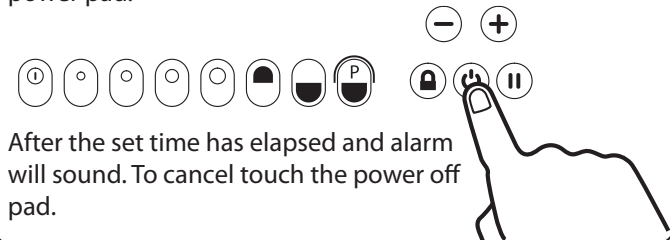

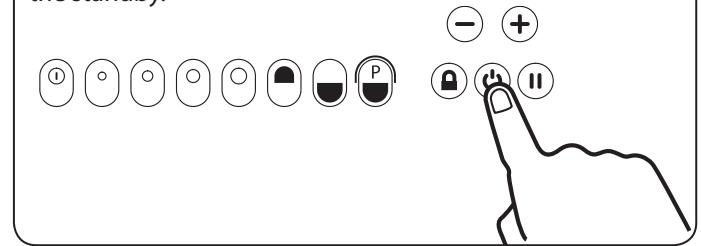

Modify Kitchen Timer

Step 1. To modify or cancel a previously set time, touch the standby.

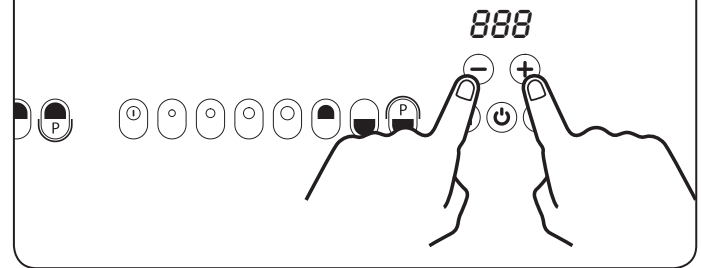

Step 2. Press the "-" and "+" button together.



Step 3. The time can now be modified by using the - or +.  to cancel.

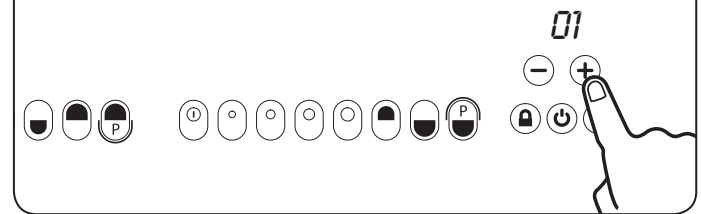

Step 4. If an instant countdown is required touch the power pad.

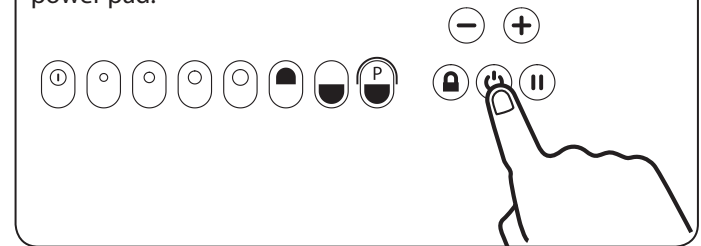

Step 5. If an instant countdown is required touch the power pad.

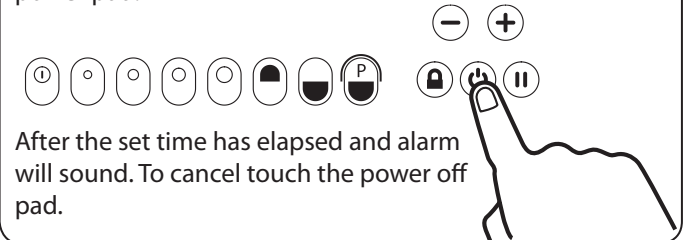

2. Minute Minder

Step 1. To switch on touch the standby.

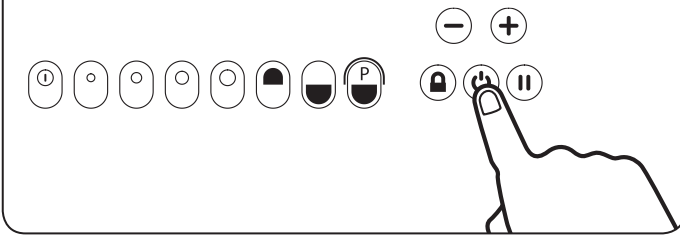

Step 2. Touch the induction on. If power level is not set within 20 seconds the unit will automatically switch off.

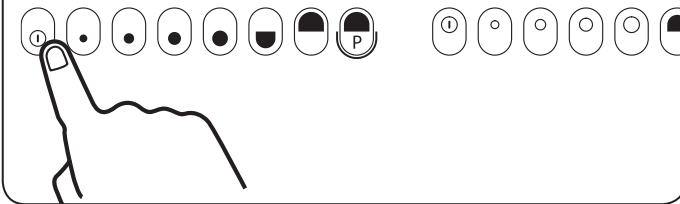

Step 3. Set the required power level.



Step 4. Press the "-" and "+" button together.

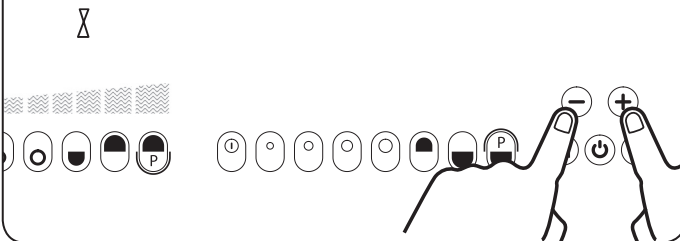

Step 5. The time can now be set by using the - or +. The count down will commence after a few seconds.

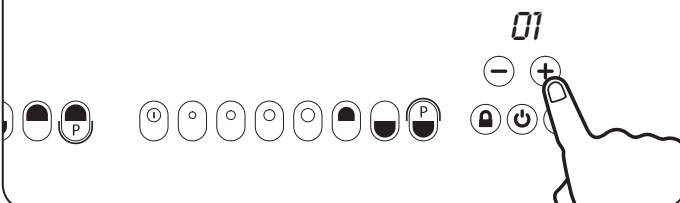

Step 5. If an instant countdown is required touch the power pad.

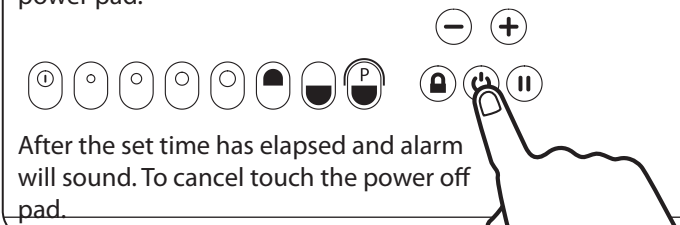

Modify Minute Minder

Step 1. Press the "-" and "+" button together.

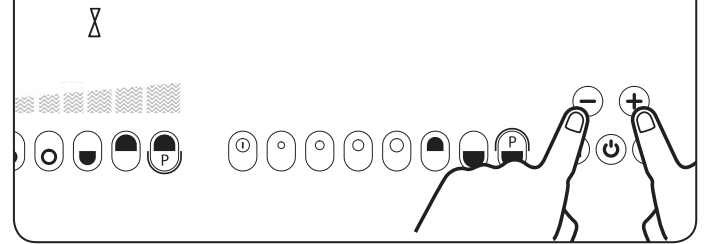

Step 2. The time can now be set by using the - or +. The count down will commence after a few seconds.

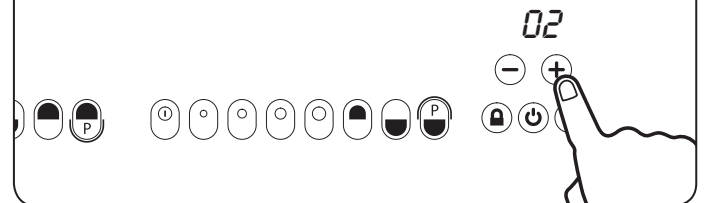

3. Temporary Lock

Temporary Lock, this feature will lock the controls for the duration of a cooking process to prevent accidental adjustment of the controls.

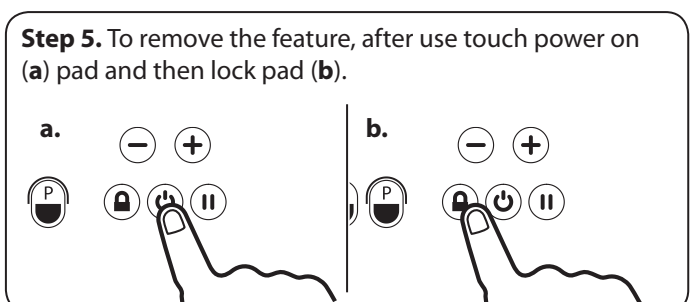
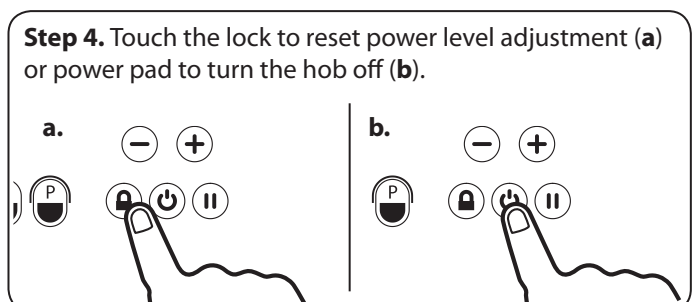
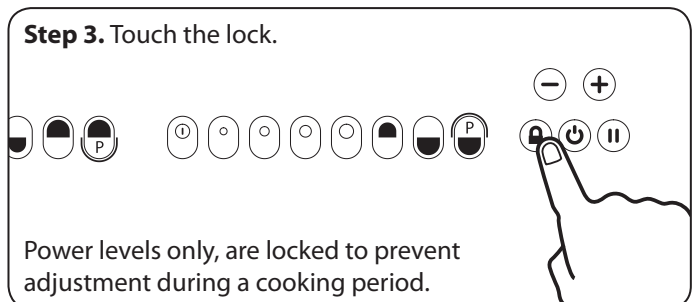
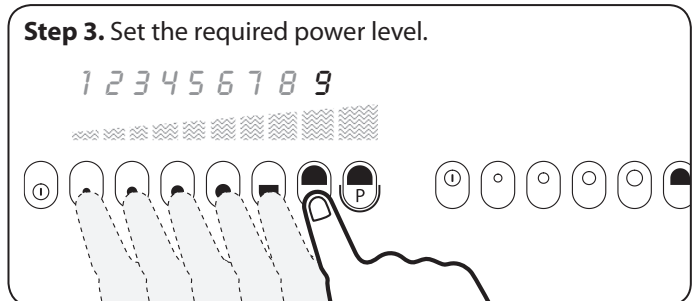
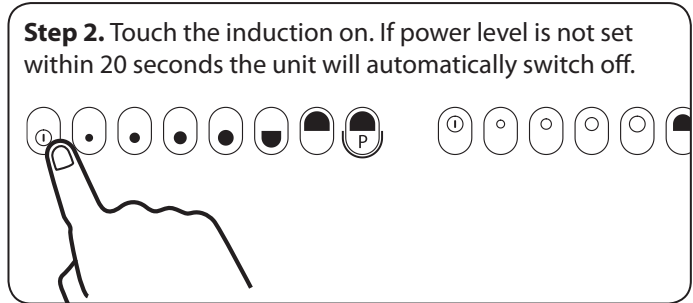
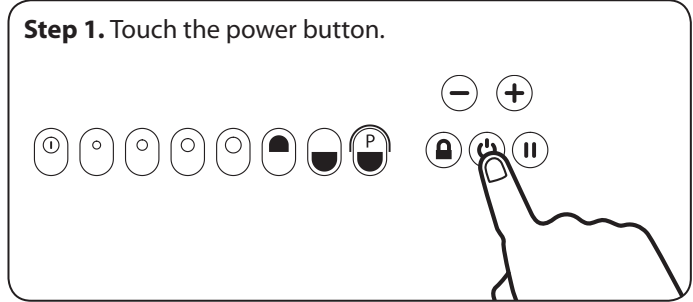

Bridge Function

The bridge function allows both cooking zones/elements to be switched on at the same time and controlled as one cooking zone only.

This is ideal for an induction compatible griddle or fish kettle for example.

Step 1. Touch the power button.

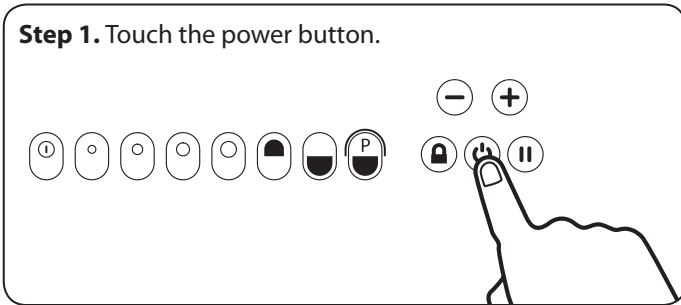

Step 2. Activate by selecting both cooking elements simultaneously.

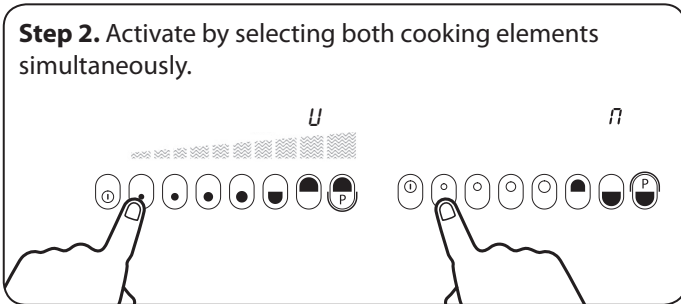

Step 3. Set the required power level by the left slider only.

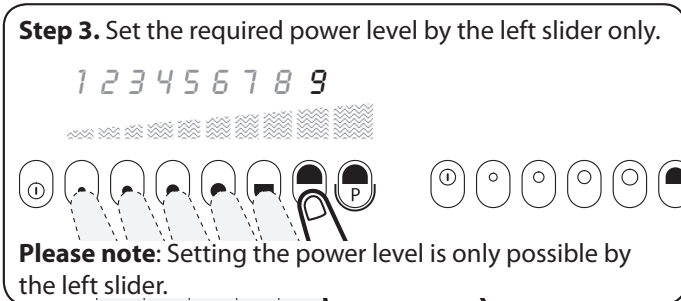

Please note: Setting the power level is only possible by the left slider.

Step 4. To switch off touch the standby.

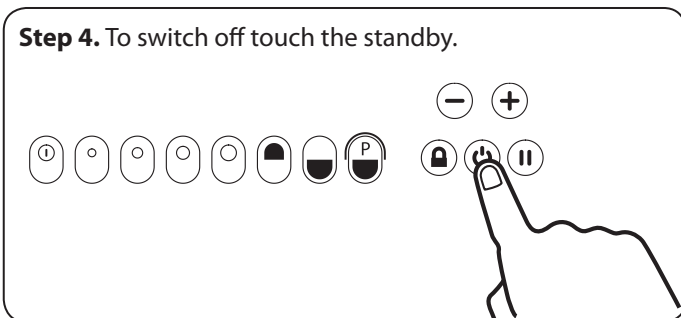

6. Warming oven shelf and plate rack

The warming oven is supplied with one flat cooking shelf (**Fig. 6.1**) and one plate warming shelf (**Fig. 6.2**).

When using the tall oven, you can cook on all four shelves at the same time, but make sure that they are well spaced out to allow the hot air to circulate.

To clean the oven sides, slide out the shelves, unhook the supports from the oven sides, and lift out (**Fig. 6.3**).

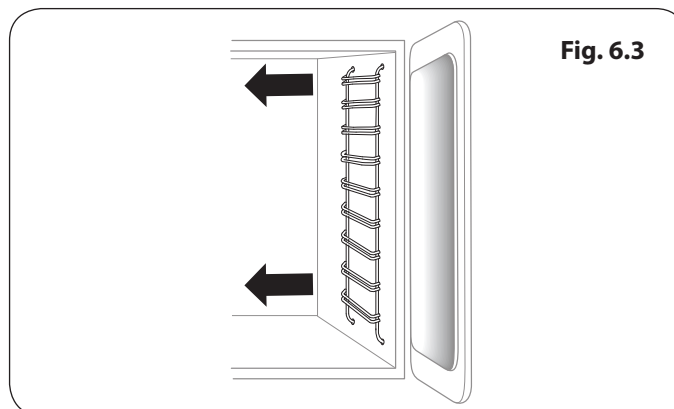
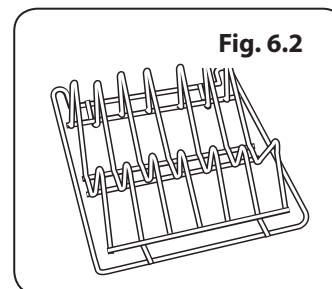
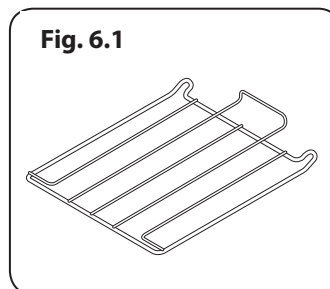

7. AGA accessories

To get the very best performance from your range we recommend AGA saucepans with the thick tri-core bases and stacking lids so that the maximum use of oven space is made and an AGA kettle for boiling water. AGA Accessories can be viewed at your AGA Specialist or online at www.agacookshop.co.uk

Getting to know your AGA

If you have not already seen a demonstration, ask your AGA Specialist for details. A demonstration will show you how to get the best from your new AGA and will give you hints and tips. You will also see a selection of AGA utensils and accessories being used.

Accessories in your AGA eR3

1x Large Size Roasting Tin with Grill Rack (Fig. 7.1)

This is designed to slide onto the oven runners without the need for it to sit on an oven grid shelf. The roasting tin can be used with the grill rack, in its high position, for grilling at the top of the roasting oven. It can be used for roasting meat, or poultry with or without the grill rack. Large quantities of roast potatoes can be cooked in this tin. The roasting tin can also be employed for making large traybakes or cakes. The grill rack is useful on its own as a cake cooling rack. It can be used in any oven but not recommended for hotplate use.

1x Half Size Roasting Tin and Grill Rack (Fig. 7.2)

This tin can be slid onto the oven runners width-ways or can sit on an oven grid shelf. The half size roasting tin can be used with the grill rack, in its high position, for grilling at the top of the roasting oven. It can be used for roasting smaller joints of meat, or poultry with or without the grill rack. Roast potatoes can be cooked in this tin. The roasting tin can also be employed for making traybakes or cakes. The grill rack is useful on its own as a cake cooling rack. It can be used in any oven but not recommended for hotplate use.

2x Floor Grid (Fig. 7.3)

This grid is used on the floor of the ovens, in particular the roasting and simmering ovens to protect food needing over 30 minutes cooking from the intensity of the heat from the base element.

2x Oven Grid Shelves (Fig. 7.4)

These are for inserting in each oven to provide a surface for dishes and tins which do not fit direct onto the oven runners. They can be used in any oven, as required.

1x Warming oven Shelf

1x Plate rack



Fig. 7.1



Fig. 7.2

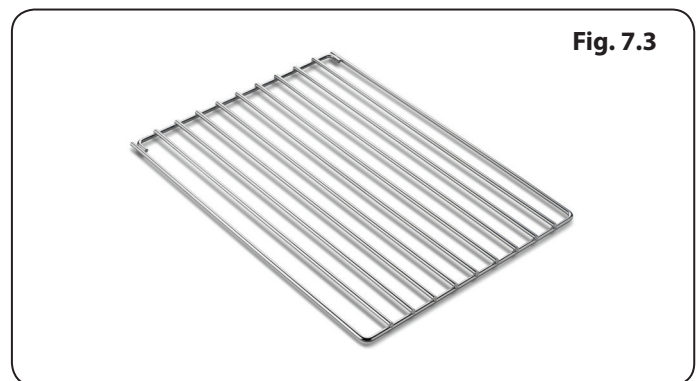

Fig. 7.3

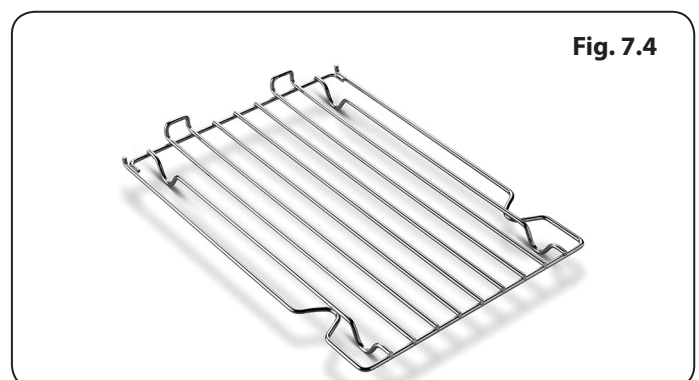

Fig. 7.4

Fig. 7.5



1x Cold Plain Shelf (Fig. 7.5)

This has two uses one as large baking sheet for scones, biscuits, pastry items and meringues and the other use as a heat deflector to cut off the top heat if food is overbrowning before it is cooked through.

⚠ DO NOT STORE IN THE OVENS WHEN NOT IN USE.

1x Toaster (Fig. 7.6)

This is for toasting bread on the boiling plate. AGA toast is renowned for its excellence, crisp on the outside and soft in the centre. Take thick slices of bread and place in the AGA toaster - if the bread is very moist or very fresh, heat the toaster beforehand to prevent sticking - lift the boiling plate insulated cover and place the toaster direct onto the plate with the handle at an angle from the handle of the cover.

Close the cover and wait for the bread to toast one side - this will take 1-2 minutes dependent upon the variety of bread - open the cover and turn the toaster over and repeat the process to toast the other side. The toaster can also be used for heating pitta bread, toasting teacakes and as a cake cooling rack.

1x Wire Brush (Fig. 7.7)

This is for cleaning the raw cast iron surfaces, keeping them clear of crumbs and burnt on debris - which would otherwise affect the boiling performance of pans and the kettle. Use on the hotplates and the ovens. Take care not to touch the enamel surfaces as the wire brush will scratch the finish.

1x Resting plate lifting tool (Fig. 7.8)

To aid removal of the cast iron resting plates for cleaning.

Fig. 7.6

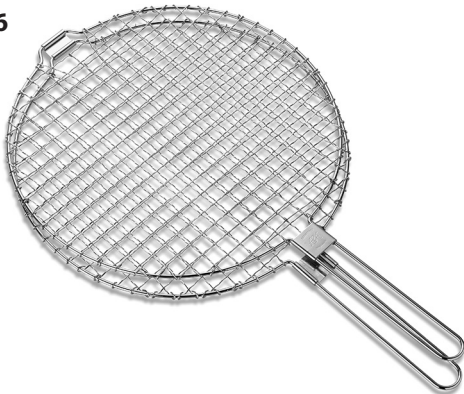
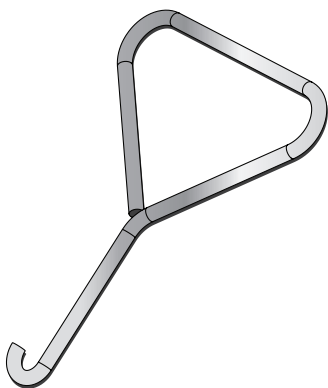

Fig. 7.7



Fig. 7.8



WARNING:

Accessible parts may become hot during use. To avoid burns and scalds children should be kept away.

8. Cleaning & caring

- ⚠ **REMEMBER: be careful of the hot appliance.**
- ⚠ **For most cleaning it is best when the appliance is turned off.**
- ⚠ **DO NOT use a steam cleaner to clean this cooker.**
- ⚠ **DO NOT use abrasive pads, caustic cleaners, oven cleaners or metal scrapers to clean the surfaces of the enamel.**
- ⚠ **IMPORTANT: AGA recommend Vitreous Enamel Association approved cleaners for cleaning the vitreous enamelled surfaces of this product.**
- ⚠ **When cleaning use as little water as possible.**
- ⚠ **DO NOT immerse the doors in water as they are packed with insulating material, which will be damaged by excessive moisture.**
- ⚠ **DO NOT put oven doors or resting plates in a dishwasher.**

All that is usually needed to keep the vitreous enamelled surfaces of your cooker bright and clean is a daily rub over with a damp, soapy cloth followed immediately with a clean, dry cloth to avoid streaks.

Ovens and Hotplates - are made from cast iron and keep themselves clean. They are very durable, but will rust if surface moisture is left on them. Remember to always switch the ovens on, to dry them out after cleaning.

Heating up the ovens periodically will help burn off any cooking deposits to aid cleaning within the ovens.

To season the ovens, a light vegetable spray oil (corn oil is best) is recommended. Any stubborn stains can be removed with the wire brush supplied.

Enamelled cast iron The easiest way to clean the AGA top plate and front plate is to mop up spills as they happen. VEA approved AGA Enamel Cleaner can be purchased from www.agacookshop.co.uk.

Baked on food is more difficult to clean but can usually be removed with proprietary vitreous enamel cleaners or mild cream cleaners using a cloth, or if necessary, a nylon scouring pad and can be purchased from www.agacookshop.co.uk.

If milk or fruit juice, or anything containing acid is spilt on the enamel, wipe off immediately.

Clean off any condensation streaks on the front plate around the oven doors or vitreous enamel maybe permanently discoloured.

Remember the top plate and the polished covers will scratch if pans or utensils are dragged across them.

The top of the insulated cover (lid) This is chrome or stainless steel and can be kept clean by wiping over with a damp cloth and polished up - the AGA E-cloths are excellent for this purpose as they are lint-free and eco-friendly. AGA stainless steel and chrome cleaner are recommended to keep the insulated cover clean and shining. These can be purchased from your local AGA Specialist.

Lining of the insulated cover (lid interior) The use of an AGA splash shield is recommended to keep the lining free of fat splashes, (obtainable from your AGA Specialist or on-line at www.agacookshop.co.uk).

If the lining is marked it is best cleaned when the hotplate is cold. It can be cleaned with hot soapy water and/or a cream cleanser. If badly marked then a soap impregnated pad can be used - this should be used in a circular motion.

The first few times a soap impregnated pad is used you will see the circular marks, these will become reduced and the surface of the lining becomes shinier each time when used. Do not use excessive water and make sure the lining is dry before closing the cover.

Oven door linings The linings can be cleaned with hot soapy water, a cream cleanser or soap impregnated pad. To deep clean the lining place a towel on the work surface and carefully lift off the oven door (doors are heavy) and place it enamel side down on the towel padding. Clean with a soap impregnated pad to remove stubborn marks. Dry off before replacing on their hinges.

Enamelled roasting tins Those supplied with the appliance should be cleaned in hot soapy water, soaking if necessary. A nylon scouring pad can also be used. They may also be cleaned in the dishwasher, but with constant use, the enamelled finish will become dull in appearance.

Induction Hob The easiest way to clean the ceramic top on the AGA Induction hob is to mop up spills as soon as they happen. It maybe useful to keep a damp cloth handy to do this. The ceramic surface should then be cleaned with a proprietary cleaner such as Hob Brite.

- ⚠ **DO NOT USE HOB BRITE ON ENAMELLED SURFACES.**

9. Maintenance

- Your AGA does not need to be regularly serviced.
- In the event of requiring maintenance, please call AGA Service or your authorised distributor.
- Your appliance **MUST** only be maintained and installed by a qualified engineer, AGA engineer or an authorised distributor.
- **DO NOT** alter or modify the appliance.

 **Work cannot be carried out on a hot appliance.**

Spare Parts

To maintain optimum and safe performance, we recommend that only genuine AGA spare parts are used. These are available from most major spares stockists, including ourselves.

10. Installation instructions

WARNING!

Please read the Warning, Cautionary notes at the start of this section. If the information contained within these instructions is not followed, property damage or personal injury may occur.

DO NOT store or use gasoline or other flammable vapors and liquids in the vicinity of this or any other appliance.

Installation and service must be performed by a qualified installer or service agency.

WARNING! This appliance must be installed with an appropriate device that will allow permanent disconnection of the Live and Neutral conductors. During Installation or disconnection prior to any electrical work, the appliance must be permanently disconnected from the Supply (Live) and Neutral Conductors.

CAUTION: THIS UNIT IS HEAVY, PROPER EQUIPMENT AND ADEQUATE MANPOWER MUST BE USED IN MOVING THE RANGE TO AVOID DAMAGE TO THE UNIT OR THE FLOOR.

REMEMBER, when replacing a part on this appliance, use only spare parts that you can be assured conform to the safety and performance specification that we require.

DO NOT use reconditioned or copy parts that have not been clearly authorised by AGA.

**PLEASE READ THESE INSTRUCTIONS BEFORE USING THIS APPLIANCE
AND KEEP IN A SAFE PLACE FOR FUTURE REFERENCE.**

11. Installation introduction

Consumer protection

As a responsible manufacturer, we take care to make sure that our products are designed and constructed to meet the required safety standards when properly installed and used.

WARNING - ELECTRIC SHOCK HAZARD

It is the customer's responsibility to contact a qualified electrical installer to make sure the electrical installation is adequate and in conformance with the regulations.

Take special care when cutting holes in walls or floor. Electrical wires may be behind the wall or floor covering and could cause an electrical shock if you touch them.

Locate any electrical circuits that could be affected by the installation of this product and disconnect power circuit.

WARNING: THIS APPLIANCE MUST BE EARTHED.

DO NOT use an extension lead with this appliance.

The appliance is designed for the voltage stated on the data plate.

Recommended but not mandatory to fit an individual Residual Current Device (RCD) to the cooker supply circuit.

Hand this Manual to the User for retention and instruct in the safe operation of the appliance.

12. Installation and Levelling

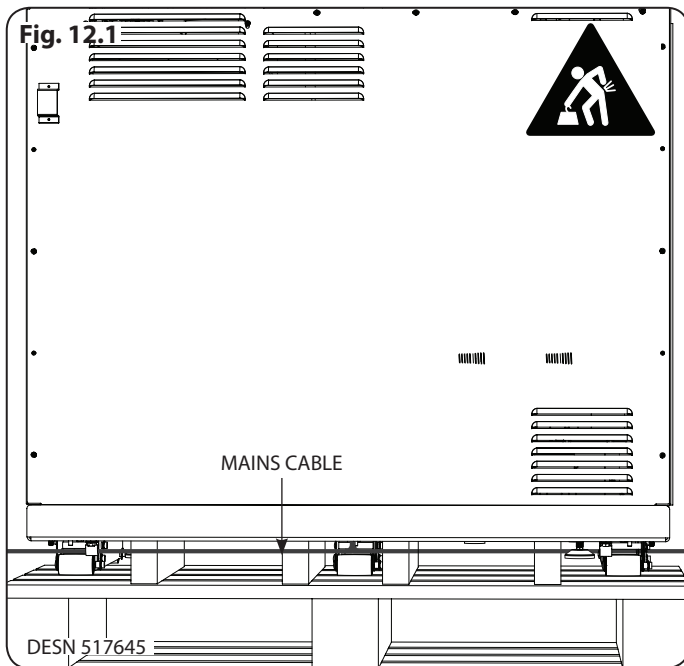

1. **NOTE:** Care must be taken not to trap mains cables (**Fig. 12.1**).
2. When removing appliance from the pallet, the front stability feet can be raised with a spanner to allow appliance to be slid from transit pallet (**Fig. 12.2**).
3. Slide cooker off transit pallet.

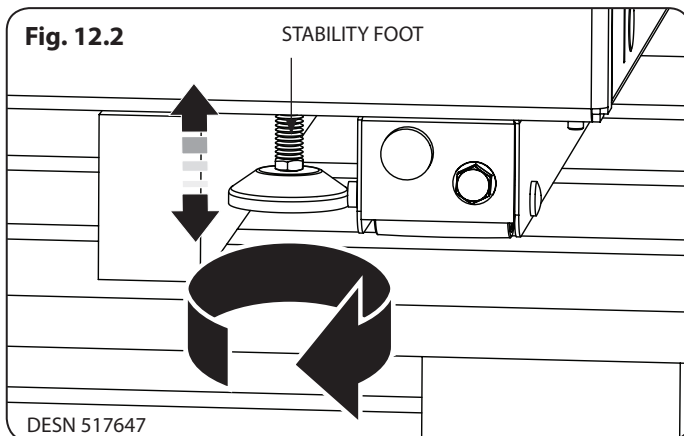

4. Appliance can now be pushed back on its wheels into desired position. **NOTE:** Care must be taken not to trap mains cable.
5. **Levelling of appliance** - Use 12mm socket to adjust wheel mechanism for FINE adjustment on both sides at rear of the appliance (**Fig. 12.3**).
6. Using a 13mm open end spanner, feet can be adjusted at front to make **FINE** adjustments to the front of the appliance and to provide a brake for the wheels (**Fig. 12.3**).
7. Turning the bolt clockwise will lower the wheel thus increasing height of the cooker (**Fig. 12.3**).
8. Anti-clockwise lifts the wheels and lowers the cooker (**Fig. 12.3**).
9. Fit the magnetic plinth (**Fig. 12.4**) and sides.
10. **Resting Plate Adjustment** - Resting plates have adjuster screw feet for setting of height and to improve stability (**Fig. 12.5**).

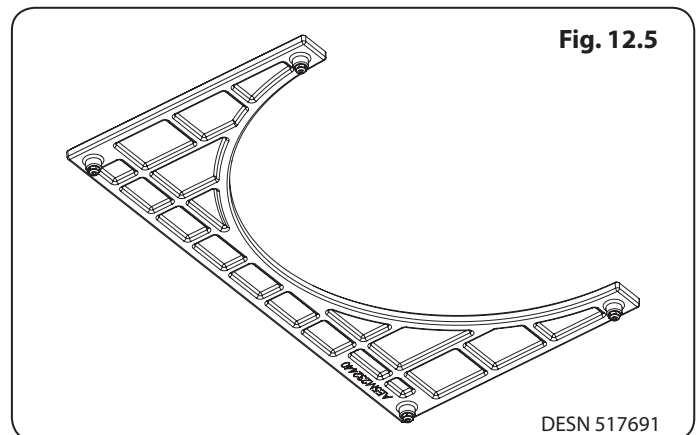
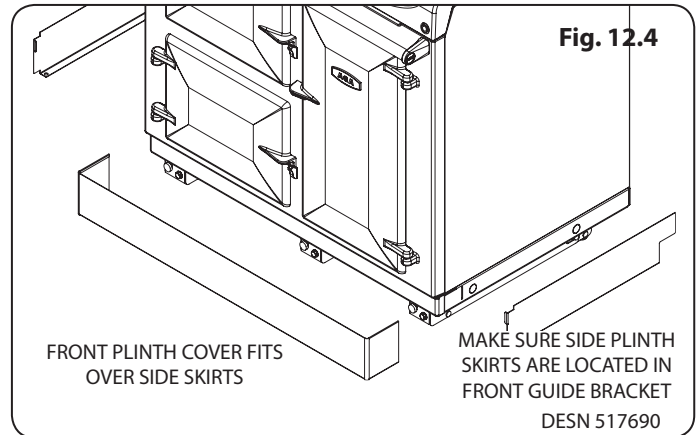
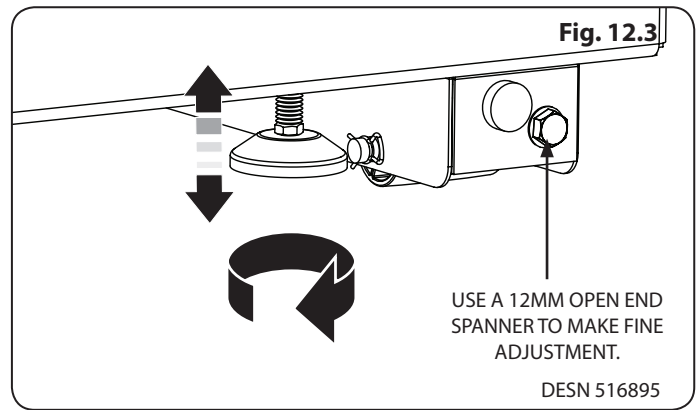

13. Product Dimensions

90 & 90i

Fig. 13.1

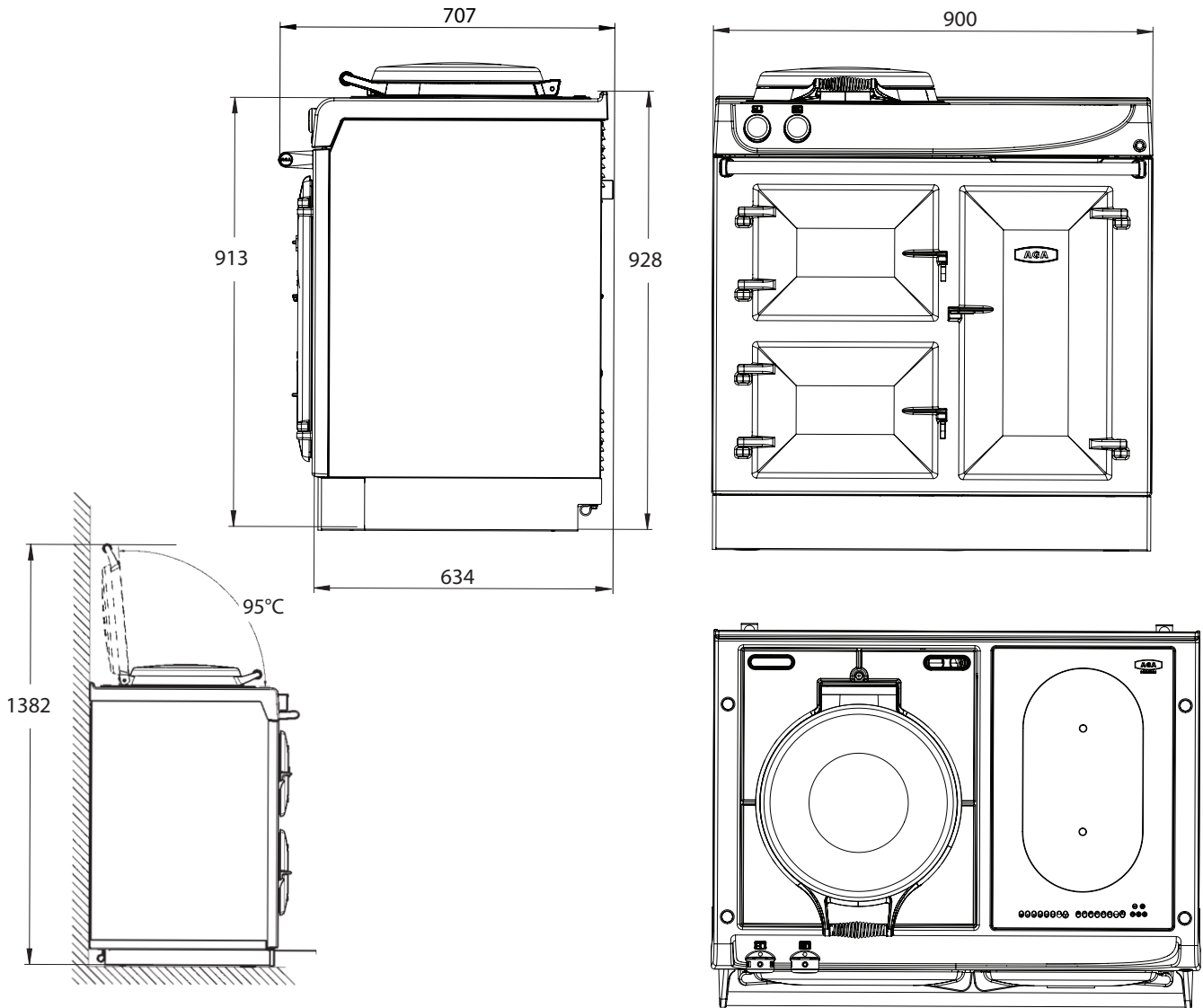

DESN 517618

NOTE: When surveying for a appliance installation the actual clearance required for the 'body' of the appliance should be increased overall by 10 mm ($\frac{3}{8}$) beyond the figures quote above. This allows safe margin to take into account the natural dimensional variations found in major castings in particular the width across an appliance recess could be critical.

Appliance weight (Excludes packaging)

Model: 90 & 90i

Weight: 300 kg

Fig. 13.2

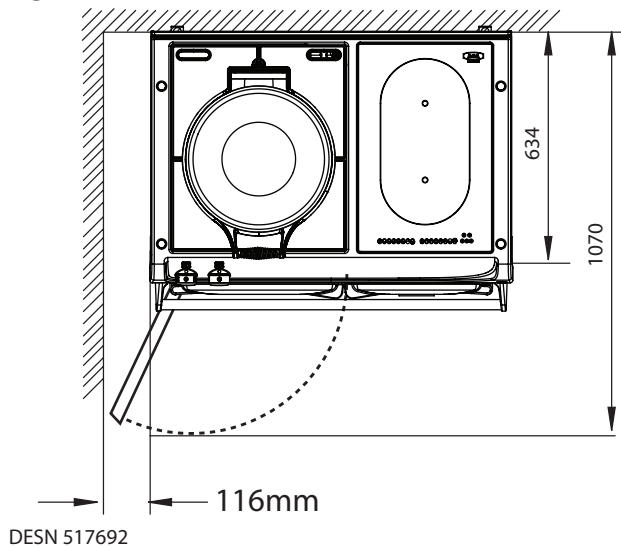

Side and Overhead Clearances

If you are installing the appliance in a new kitchen or have the opportunity to set the width between kitchen units, it is advisable to include an additional small gap each side of 3mm to assist with installation and prevent damage when moving the product.

A 6mm additional width clearance should also be provided if the appliance is to go into a brick recess, to allow for the wall being out of square.

Where installed against a side wall protruding in the front of the appliance a 116mm clearance is required on the left or right hand side for the oven door access (**Fig. 13.2**).

Any side wall above the appliance on either side shall not be less than 60mm horizontally from the appliance (**Fig. 13.3**).

Surfaces over the top of the appliance must not be closer than 650mm i.e. cabinets or cookerhoods.

The rear gap at the rear of the appliance **MUST NOT** be blocked off or obstructed.

Fig. 13.3

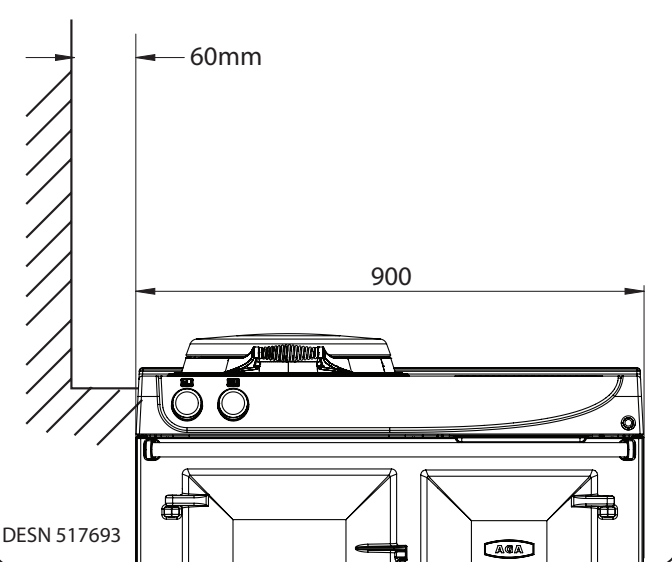

Appliance Base or Hearth

⚠ If the appliance is placed on a base, measures have to be taken to prevent appliance from slipping from the base.

It is essential that the base or hearth on which the appliance stands should be level and be capable of supporting the total weight of the appliance.

The front plinth cover is removable and must not be obstructed by flooring or tiles. If necessary the appliance must be raised by the thickness of the tiles to ensure the plinth can be removed, and the appliance can be rolled out for service.

Tiling

When the appliance is to stand in a recess or against a wall which is to be tiled, under no circumstances should the tiles overlap the appliance top plate, access to remove the top plate must be allowed for servicing at a later date.

Option Pre-heat Timer Kit (AE4M231659)

If the optional pre-heat timer kit is fitted allowances must be made for timer location and the cable between the timer and appliance. Timer cable is 4 metres.

Rear Clearances (including Combustible Rear Walls)

SPECIAL NOTE: Ensure that unprotected electric cabling or plastic services do not pass within or on the outside of the wall behind or directly above the appliance. This type of material can age prematurely when exposed to continuous higher temperature.

Please note **every** appliance is fitted with 25 mm spacer brackets.

This allows the appliance to be fitted where the rear wall is constructed of combustible materials, such as all-timber or stud wall partitions and batoned plasterboard.

The air gap must be left open and not blocked off across the top edge (Fig. 13.4) for example tiled over

IMPORTANT! The air gap at the rear of the appliance must be maintained to provide ventilation for the Induction hotplate variants (90i). The air gap is also maintained for non induction appliances.

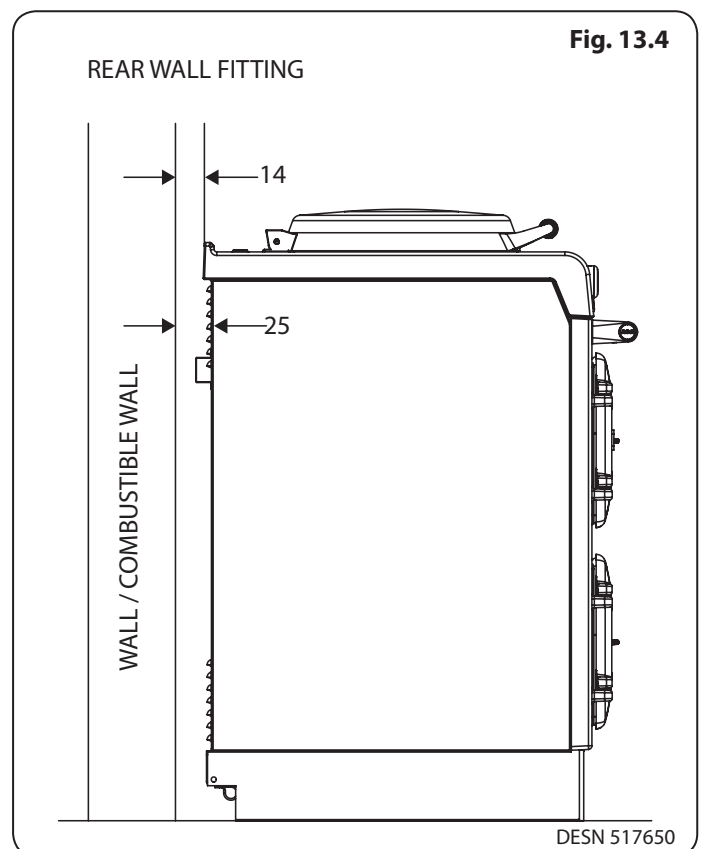

14. Electrical connection

- ⚠ WARNING: This appliance must be earthed.**
- ⚠ This appliance is designed for the voltage stated on the rating plate, which is situated behind the plinth cover.**
- ⚠ If the supply cord is damaged, it must be replaced by the manufacturer, its service agent or similarly qualified person to avoid a hazard.**

For the cooker

A 1PH 32 amp 230V or 3PH 400V minimum 16A per phase ~ 50 Hz fused electrical supply is required adjacent to the appliance. External wiring to the unit must be installed using the mains cable provided, in accordance with the current wiring regulations and any local regulations which apply. If the cable is shortened, new ferrules must be fitted to the stripped conductors.

The method of connection to the mains electricity supply must facilitate complete electrical isolation of the appliance, by a multi-pole switch, having a contact separation of at least 3 mm on all poles.

The isolator should not be positioned immediately above the cooker, but must be fitted within 2 metres of the appliance.

The isolator may be separate from the connection point.

The mains connection point must be accessible within the areas shown in **Fig. 14.1** and **Fig. 14.2** for cable routing options.

For 2 or 3 phase installations an optional adaptor kit must be obtained (Part No. AE4M280352).

Induction Hob

An additional, separate single phase power supply is required. 230V ~ 50Hz, 13amp fused three pin plug electrical supply.

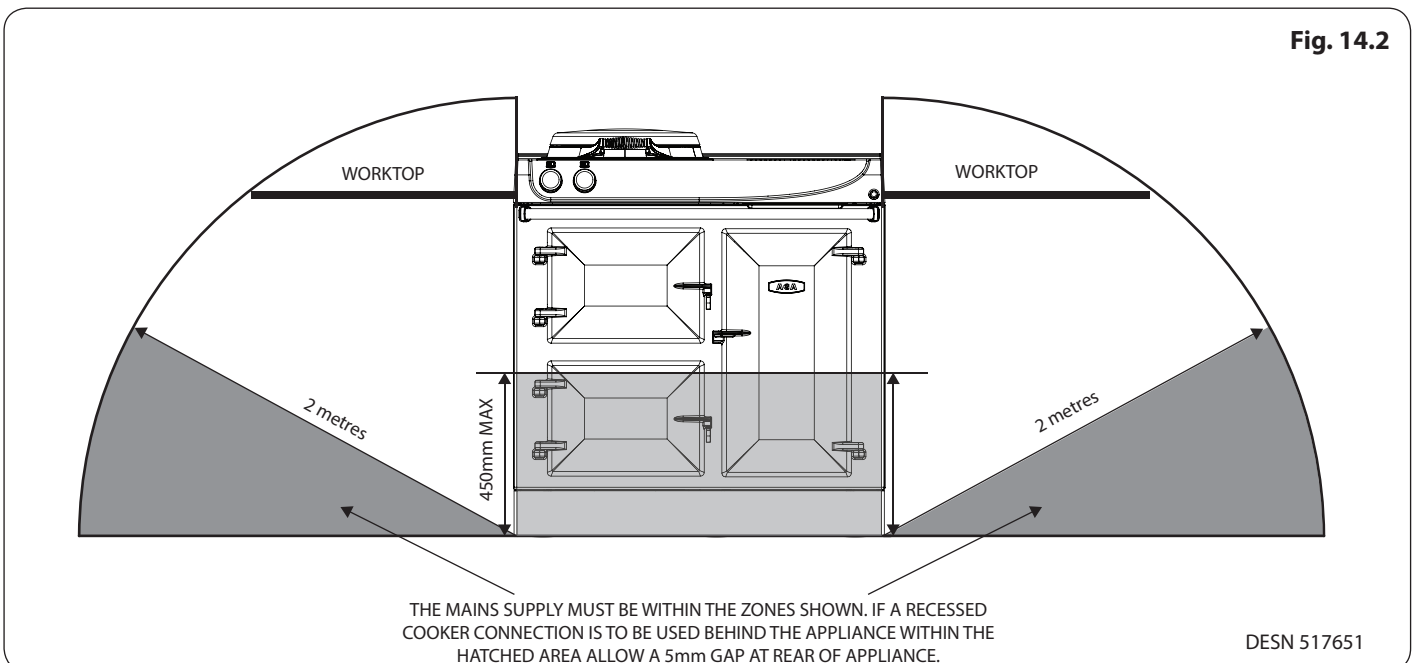
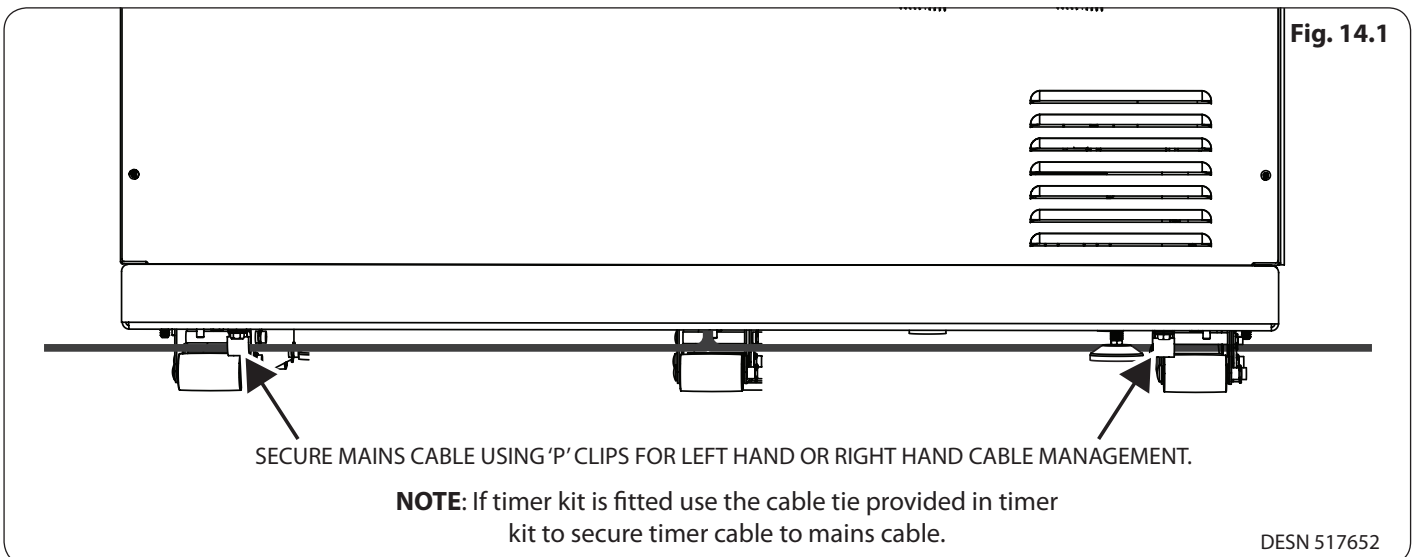

15. Control knob and handrail connection

Fig. 15.1

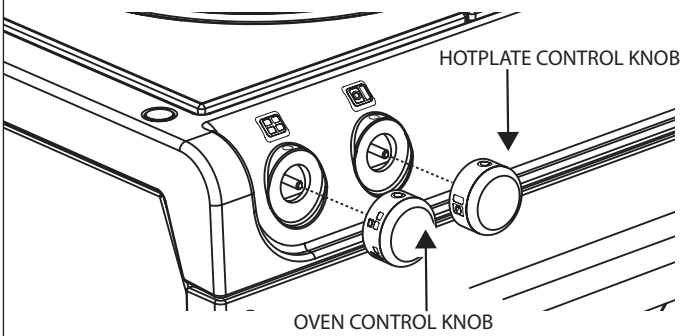

DESN 517654

Control Knob Location

Ensure control knobs are located onto spindles correctly, as shown in (Fig. 15.1).

Handrail Location

Locate handrail onto spindle, lock into position with grub screws (located on the inside of the bracket) (Fig. 15.2).

Fig. 15.2

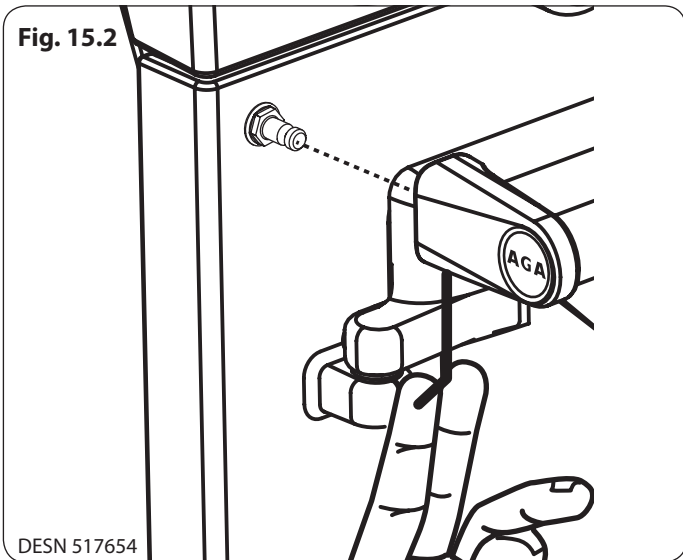

DESN 517654

16. Circuit diagram

Cooker

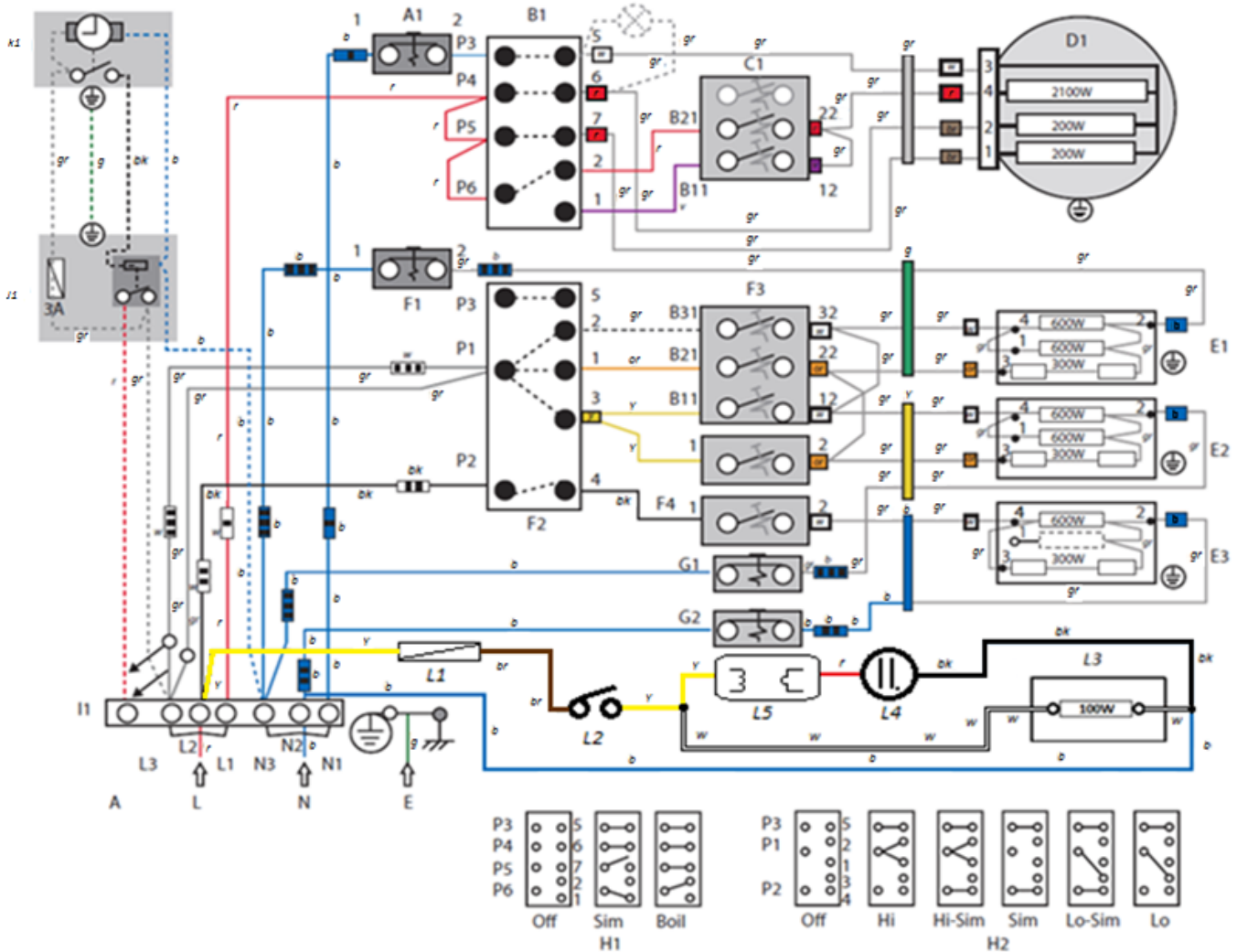

Code	Description
A1	Hotplate Overheat Thermostat
B1	Hotplate Selector Switch
C1	Hotplate Thermostat
D1	Hotplate Element
E1	Upper Top Element
E2	Upper Oven Base Element
E3	Lower Oven Base Element
F1	Upper Oven Overheat Thermostat
F2	Oven Selector Switch
F3	Upper Oven Thermostat
F4	Lower Oven Thermostat
G1	Upper Oven Overheat Switch

Code	Description
G2	Lower Oven Overheat Switch
H1	Hotplate Selector Settings
H2	Oven Selector Settings
I1	Mount Terminal Bracket
J1	Relay Box (optional timer)
K1	Upper Oven Timer (optional)
L1	Warming Oven 1A Fuse
L2	Warming Oven Switch
L3	Warming Oven Element
L4	Neon
L5	230v AC - 24v DC transformer power supply for neon

Code	Colour
b	Blue
br	Brown
bk	Black
or	Orange
r	Red
v	Violet
w	White
y	Yellow
g/y	Green/ yellow
gr	Grey

Induction Hob

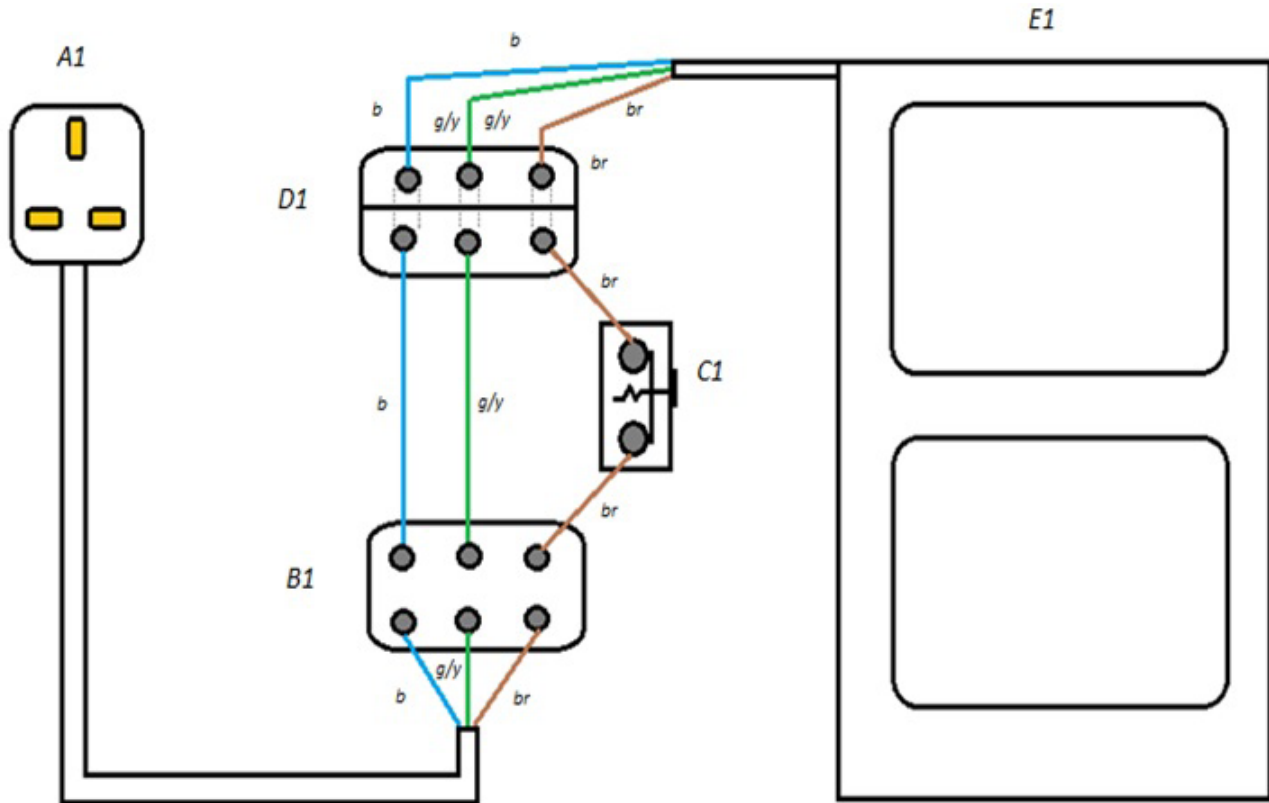

Code	Description
A1	13 A Mains Plug
B1	Terminal Strip
C1	Component Overheat Thermostat
D1	Plug And Socket Terminal Block
E1	Induction Unit

Code	Colour
b	Blue
br	Brown
bk	Black
or	Orange
r	Red
v	Violet
w	White
y	Yellow
g/y	Green/yellow
gr	Grey

**For further advice or information contact
your local AGA Specialist.**

With AGA Rangemaster's policy of continuous product improvement, the Company reserves the right to change specifications and make modifications to the appliances described and illustrated at any time.



Manufactured By
AGA Rangemaster
Station Road
Ketley Telford
Shropshire TF1 5AQ
England

www.agaliving.com
www.agacookshop.co.uk